

LOGAN MCV 2

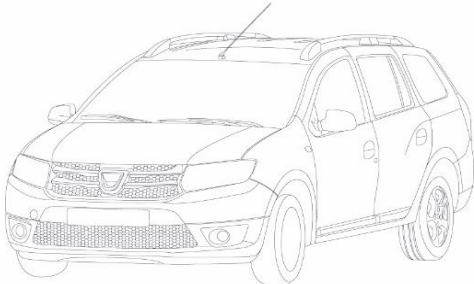

Kg 1750 kg



Kg 1150 kg

D 6,81 kN

 **Kg** 75 kg

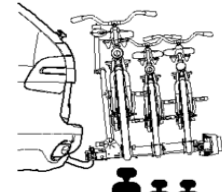
 **3 MAXI**
60 Kg MAXI

 **30 Kg MAXI**

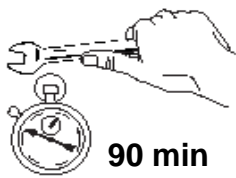
 **90 min**

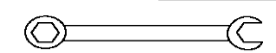
0 Km **1000 Km**



SI 217
e24*55R*01*0349

SI 218
e24*55R*01*0350

316341

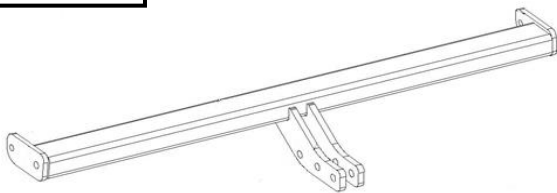

Kg 15 kg



316342

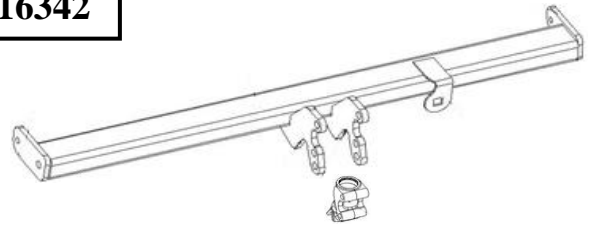

Kg 18 kg

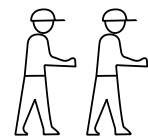
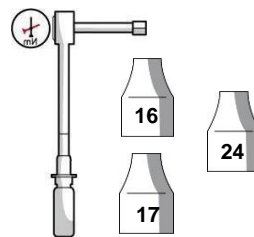
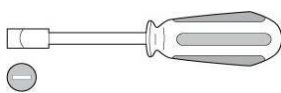



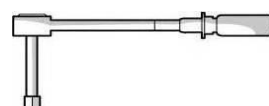



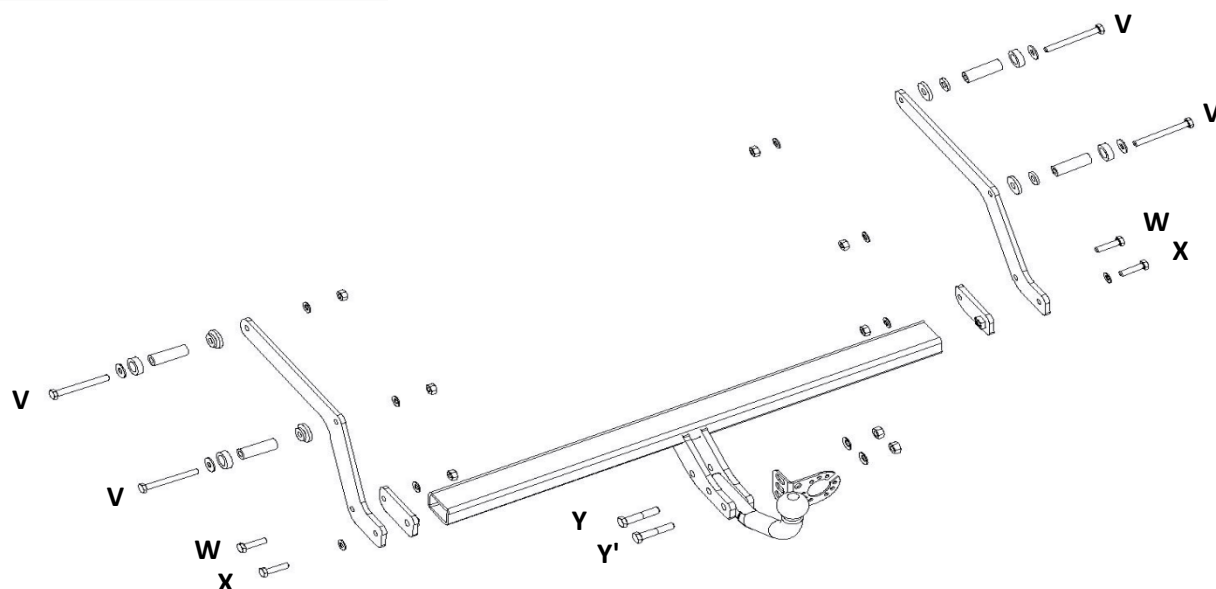









16 - 17











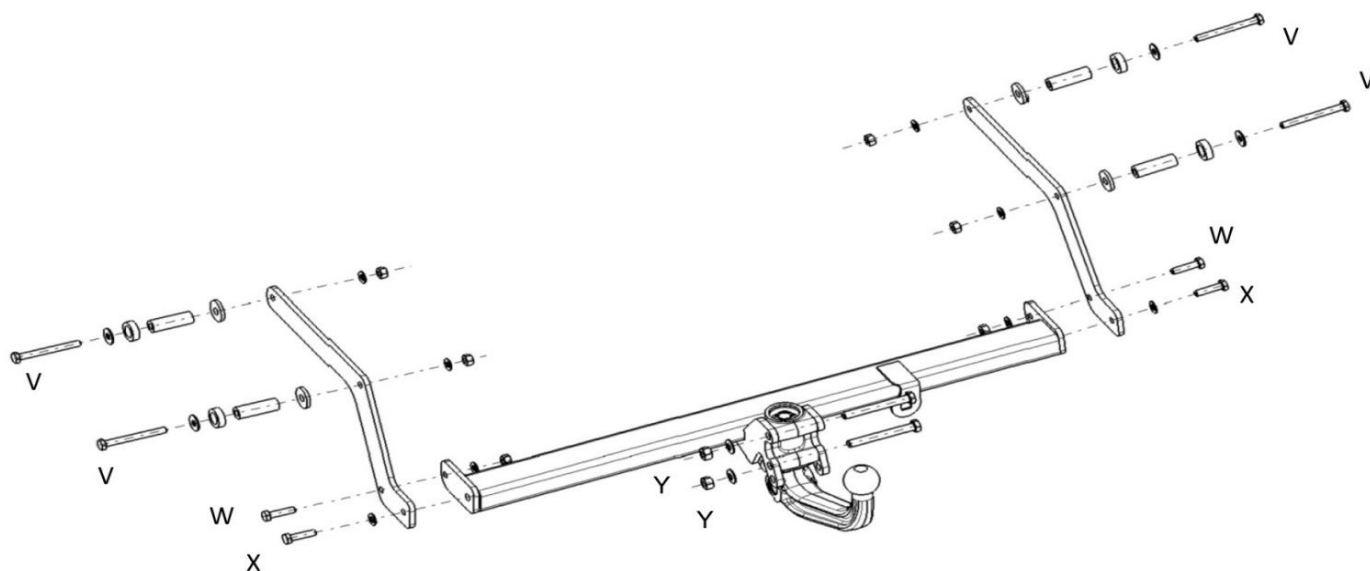





316341



VISSERIE		QTÉ
V	 HM10x95 - 67Nm	x 4
	 $\varnothing 10,5/27$	x 4
	 $\varnothing 20/32 \times 10$	x 4
	 $\varnothing 10,5/20 \text{ L}=60$	x 4
	 M10	x 4
W	 HM10x40 - 46Nm	x 2
	 CS10	x 2
	 M10	x 2
X	 HM10x40 - 46 Nm	x 2
	 CS10	x 2
Y	 HM12x60 - 81 Nm	x 1
	 CS12	x 1
	 M12	x 1
Y'	 HM12x60 - 81 Nm	x1
	 CS12	x 1
	 M12	x 1
	 D12	x 1

316342



VISSERIE		QTÉ
V	 HM10x95 - 67Nm	x 4
	 Ø10,5/27	x 4
	 Ø 20/32 x 10	x 4
	 Ø 10,5/20 L=60	x 4
	 M10	x 4
W	 HM10x40 - 46Nm	x 2
	 CS10	x 2
	 M10	x 2
X	 HM10x40 - 46Nm	x 2
	 CS10	x 2
Y	 HM12x100 - 116,5 Nm	x 2
	 CS12	x 2
	 M12	x 2

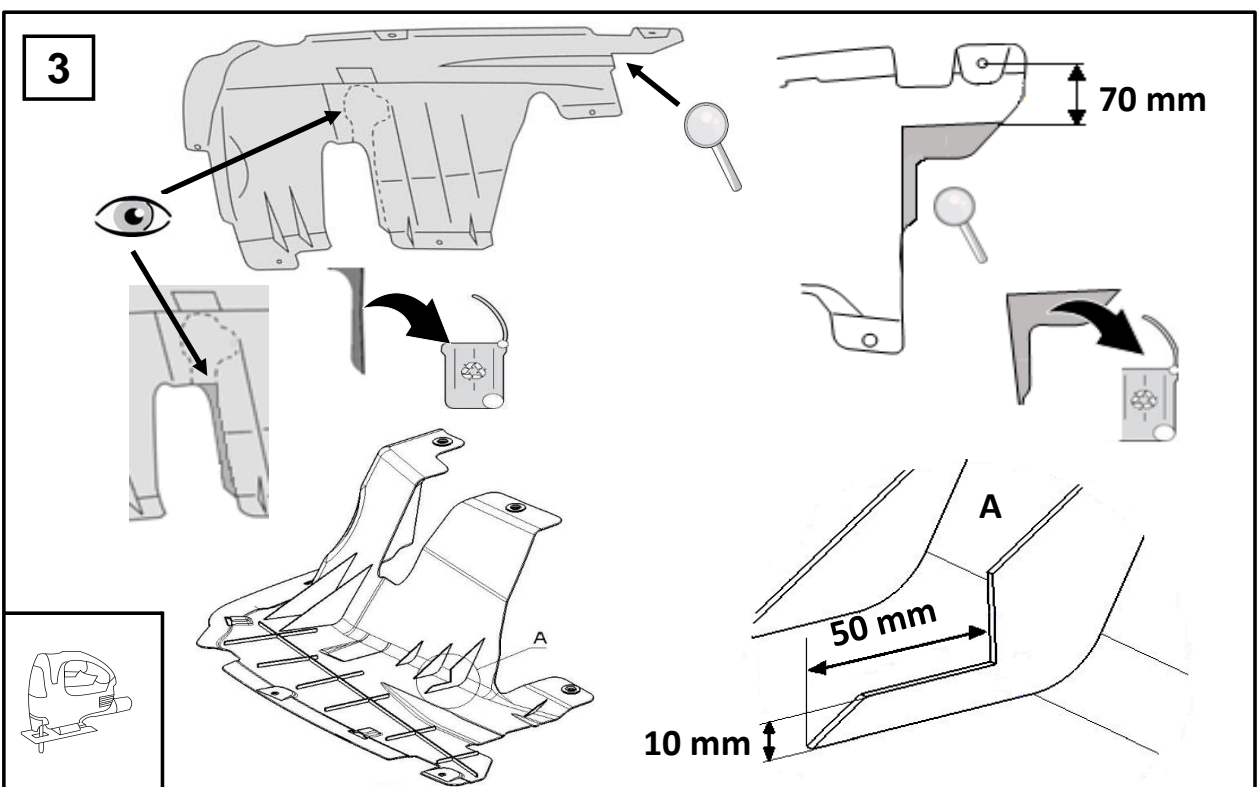
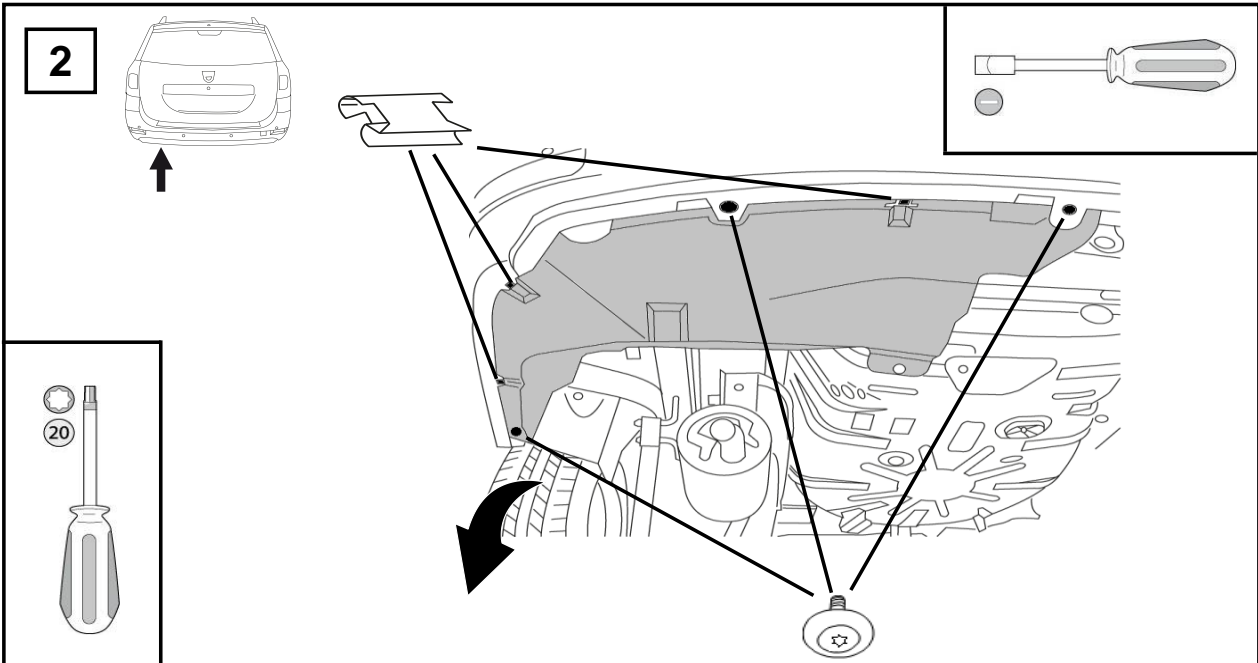
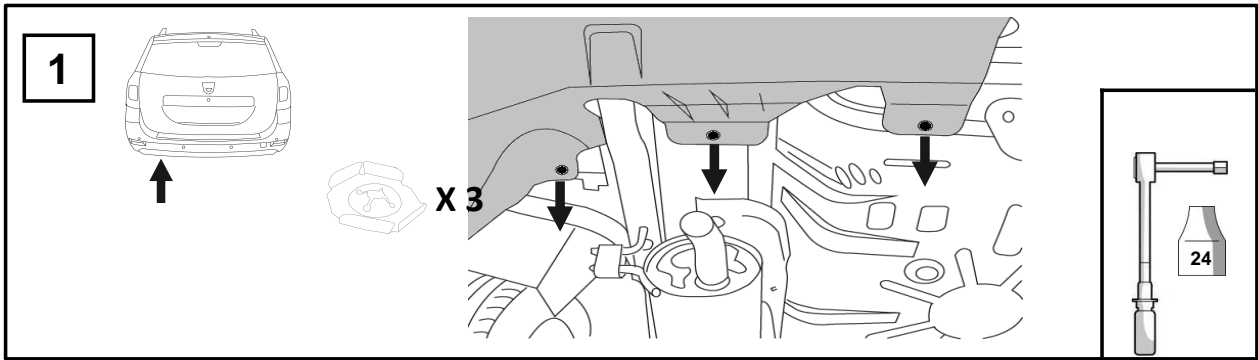

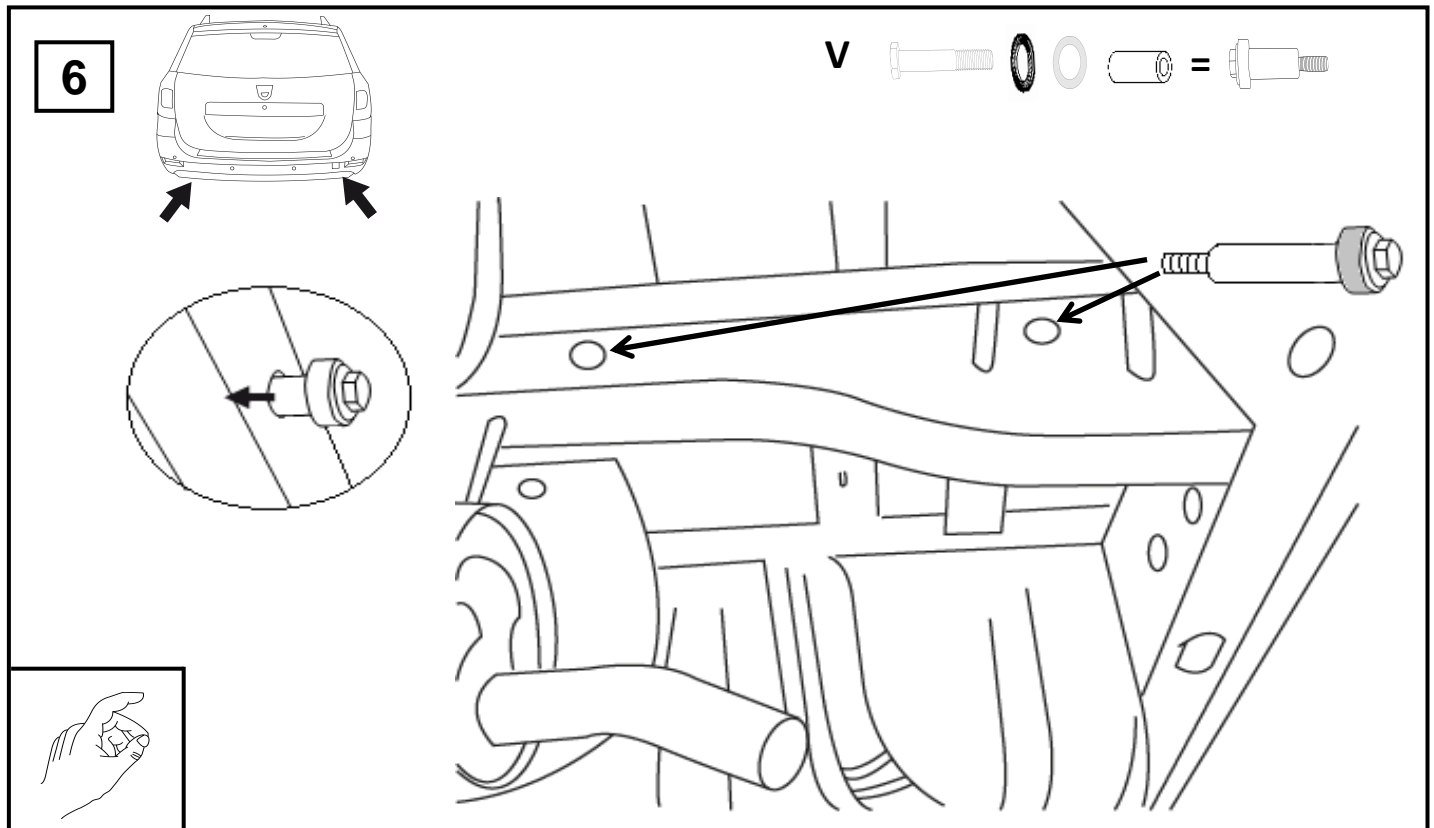
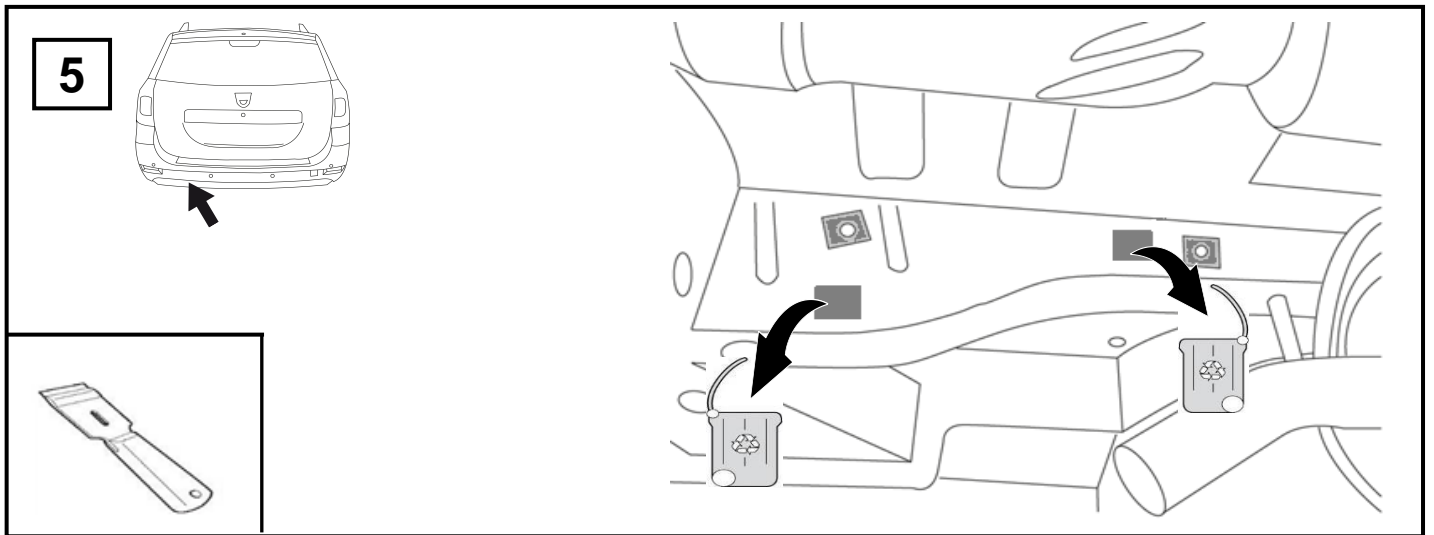
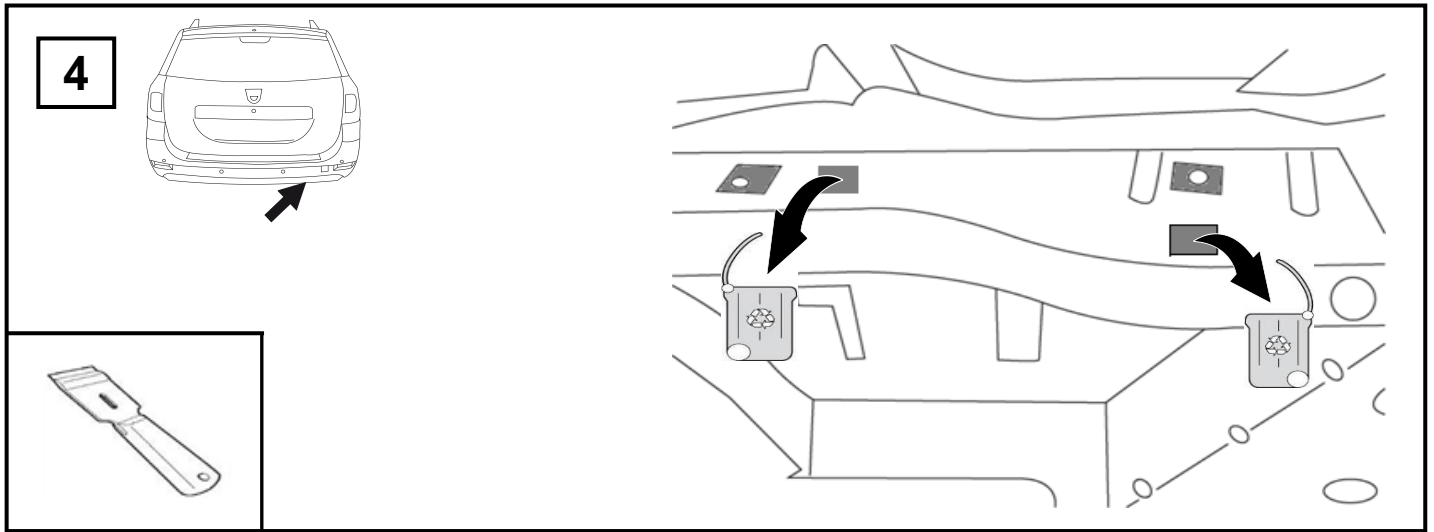

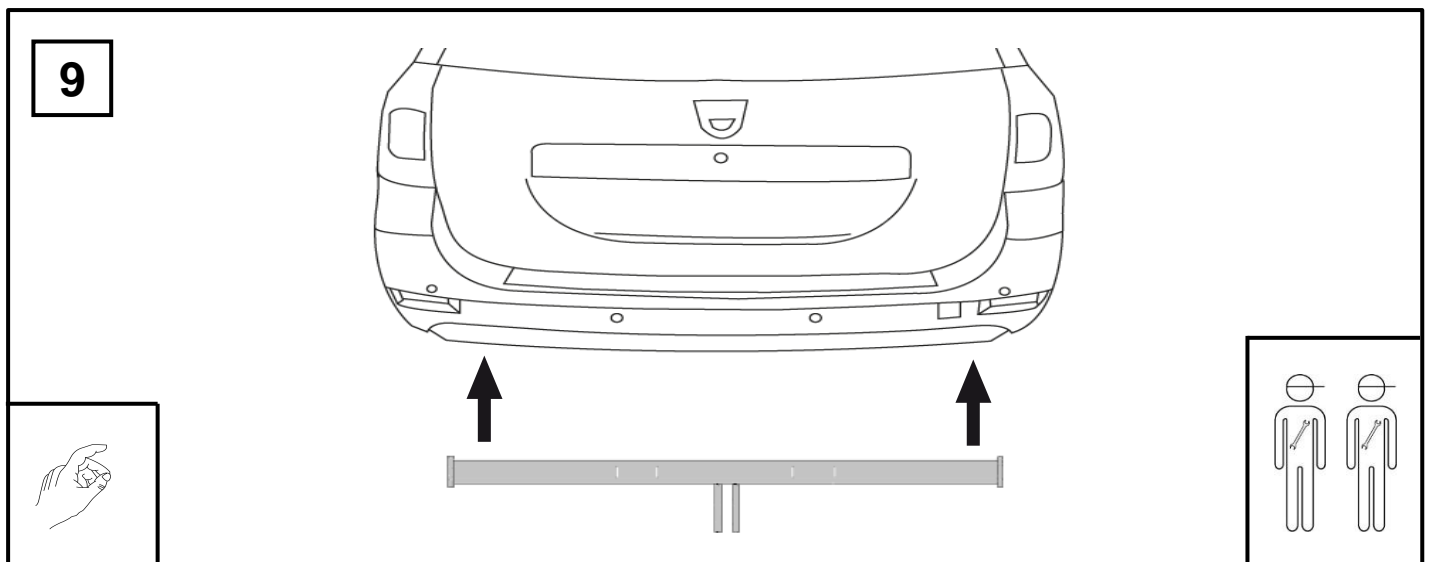
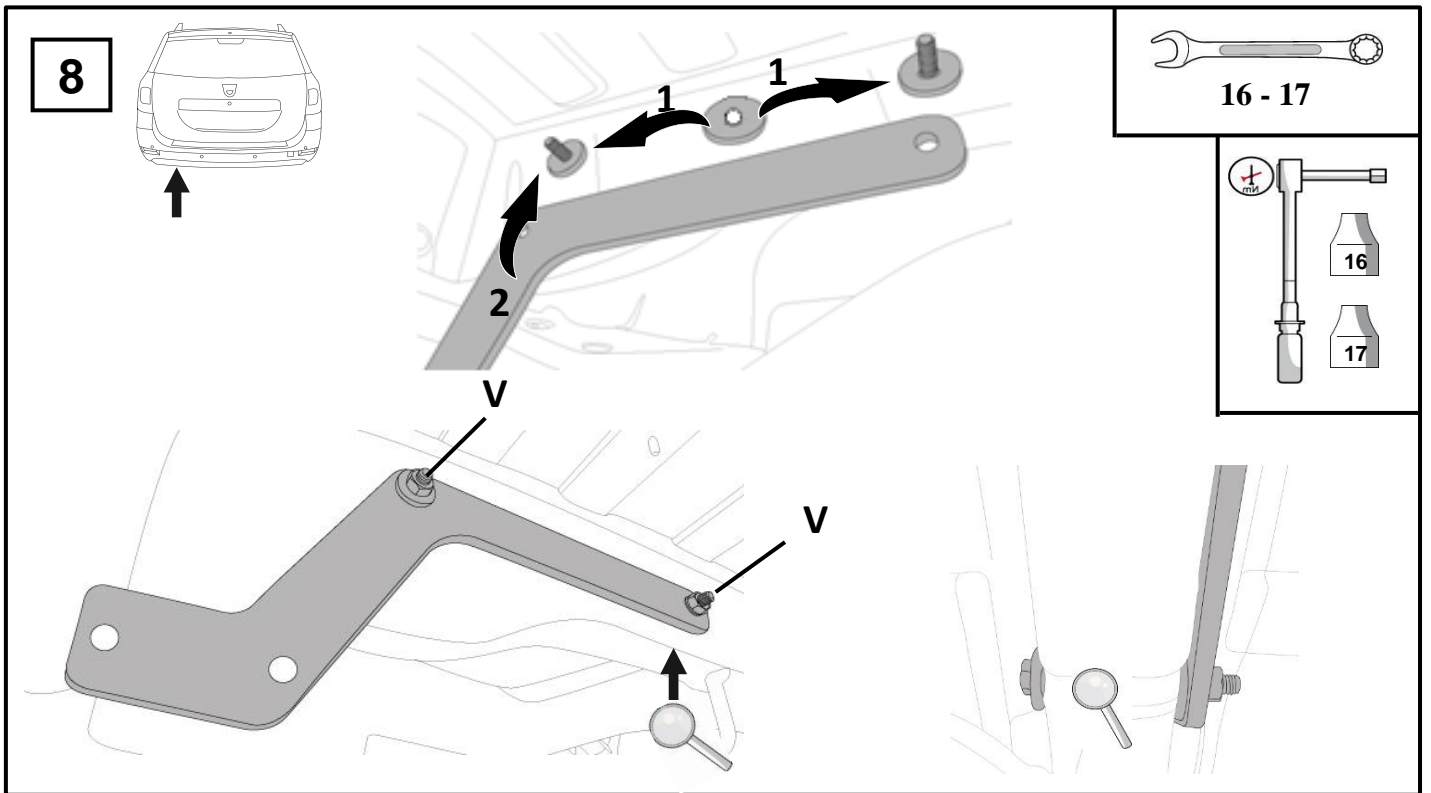
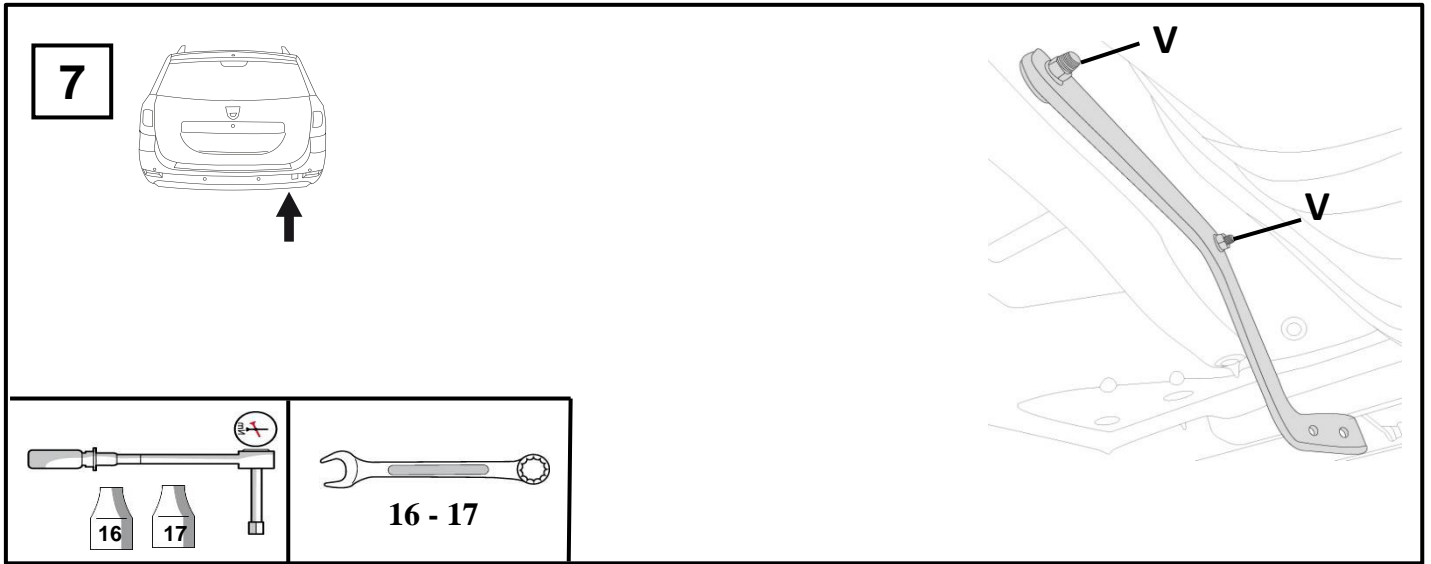

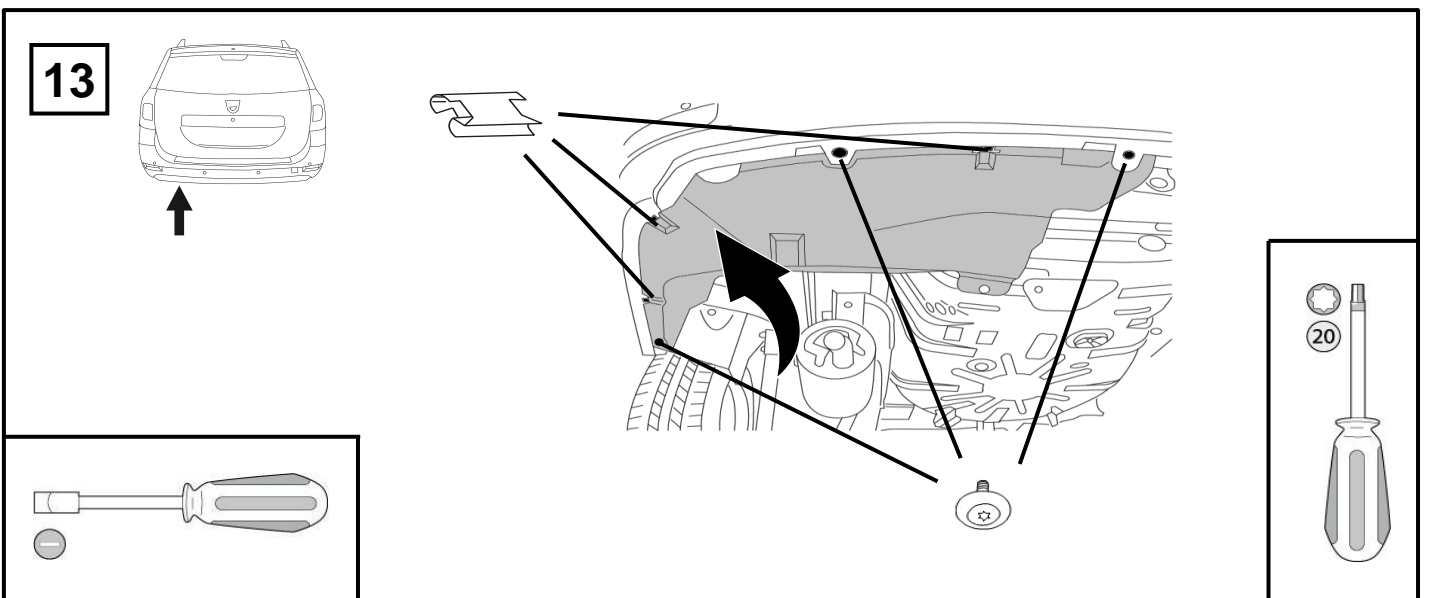
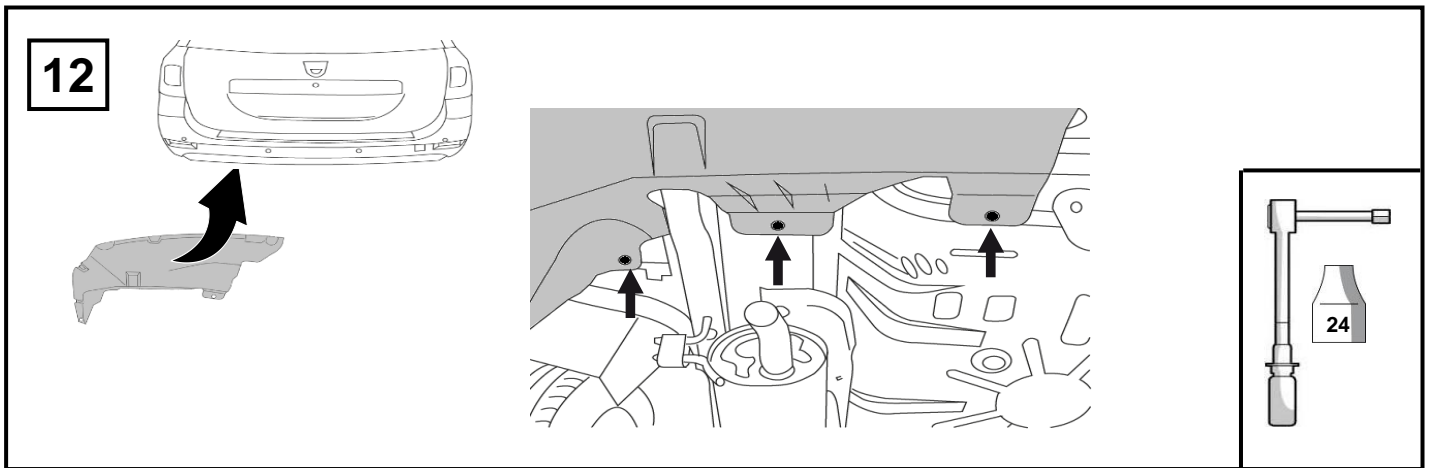
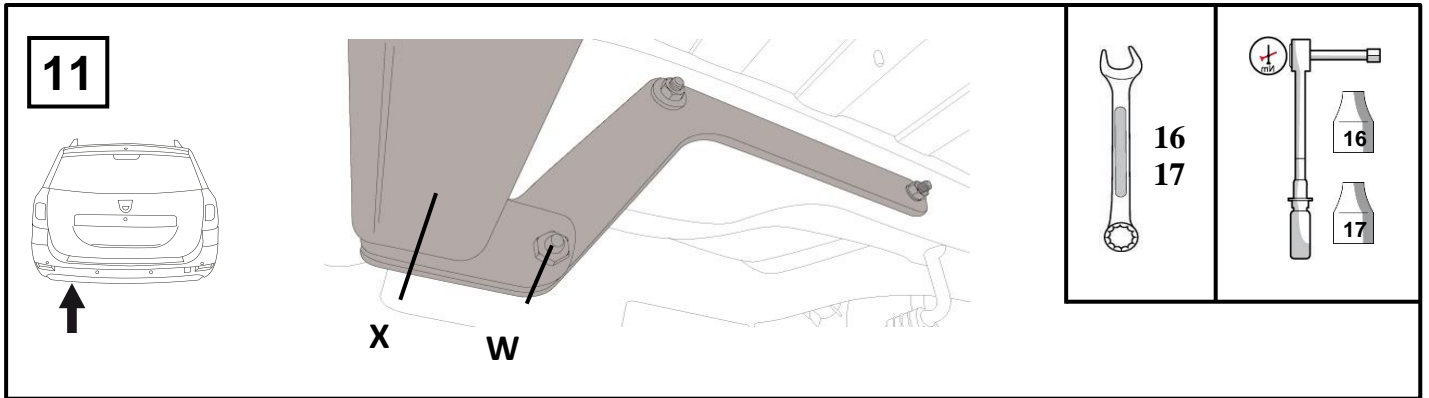
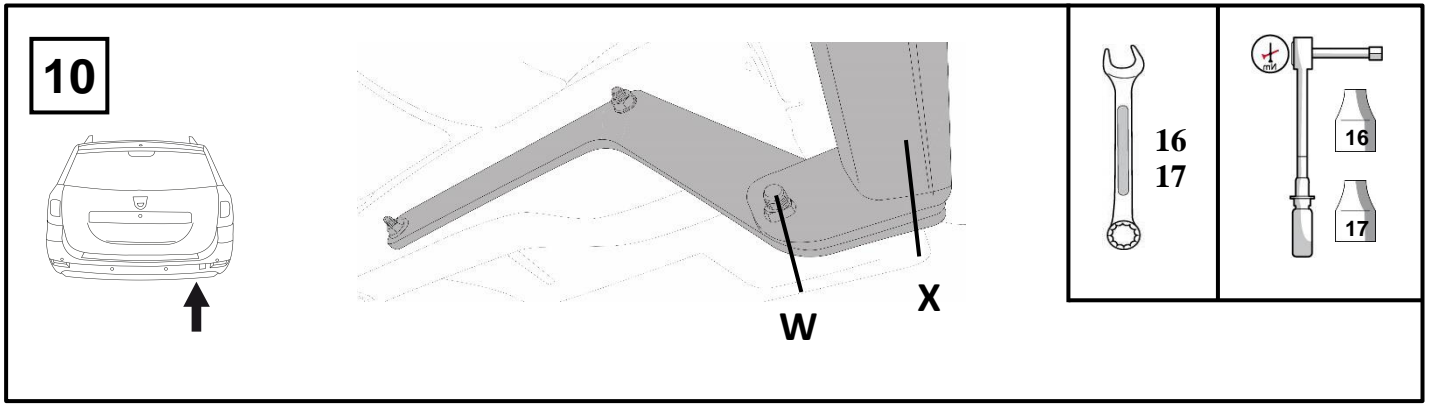

Dispositivo di traino tipo : **316341 / 316342**
Per autoveicolo : **Dacia Logan MCV**
Tipo funzionale : **SI217 / SI218**



Classe e tipo di attacco : **A50-X**
Omologazione : **e24*55R*01*0349 (316341) - e24*55R*01*0350 (316342)**
Valore D : **6,81 kN**
Carico verticale max. S : **75 kg**
Massa rimorchiabile : vedi carta di circolazione dell'autoveicolo

In base alla Direttiva europea 94/20, la massa massima rimorchiabile del dispositivo di traino è determinata dal valore di prova "D" così definito :

$$D = (T \times C) / (T + C) \times 0,00981 = 6,81 \text{ kN}$$

dove : T = Massa complessiva max. della motrice (in kg) e C = Massa rimorchiabile max. della motrice (in kg)

DICHIARAZIONE DI CORRETTO MONTAGGIO :

la sottoscritta Ditta dichiara che il dispositivo di traino tipo _____ è stato installato a regola d'arte, nel rispetto dei punti d'attacco e delle prescrizioni fornite dalla Casa costruttrice

sul veicolo Berlingo/Partner

targato _____

li _____

timbro et firma

Si dichiara inoltre di aver informato l'utente del veicolo sull'USO e MANUTENZIONE del dispositivo stesso.